

Installation Instructions

CX254 Card Cage Power Injector

Note: This installation should be made by a qualified service person and conform with local codes.

CAUTION: To reduce the risk of electric shock do not remove cover. No user-serviceable parts inside. Refer servicing to qualified service personnel.



Reduce risk of fire or electrical shock do not expose this product to rain or moisture.

NITEK®

USA Office:
5410 Newport Drive, Rolling Meadows, IL 60008
Phone: (800) 528-4343
Fax: (847) 259-1300
E-mail: info@nitek.net
WWW.NITEK.NET

Europe Office:
De Schans 19-21 2a, 8231 KA Lelystad
The Netherlands
Tel: +31(0)320-230005
Fax: +31(0)320-282186
E-mail: info@nitek.nl
WWW.NITEK.NL

Rev 072011

UTPLinks HEAD-END DISTRIBUTION

In a head-end system all equipment is located together. There is no backbone copper and all of the horizontal runs are limited to 100 meters if you are meeting TIA/EIA standards, so passive receivers can be used.

Starting at the camera end, there are several UTPLinks transmitter units available, only one is shown here. This unit allows the video, power and data to be separated out and fed into standard CCTV cameras.

From the transmitter there is a standard 4 pair Category cable running back to a patch panel up to 100 meters away for TIA/EIA standards, or 750 feet for standard fixed analog cameras. Distances for analog PTZ cameras must be determined by the power requirement of the camera. Using 24awg patch cables, connections for each camera are sent to the CX254 unit. The CX254 unit provides a central point for the combining of the power, data and video signals. Each camera port is fused and lights on each of the front panel RJ45 jacks show the status of both power and data. Power for the system is provided by CX254 unit.

Data for the CX254 is routed through the 2 pin jack on the rear of the CX254 unit. In this system CHM22 cards feed video out the front BNC jacks for connection into standard CCTV equipment. In this example, a DVR is viewed on a monitor. It could have been a matrix, multiplexer or any other equipment needed for your application.

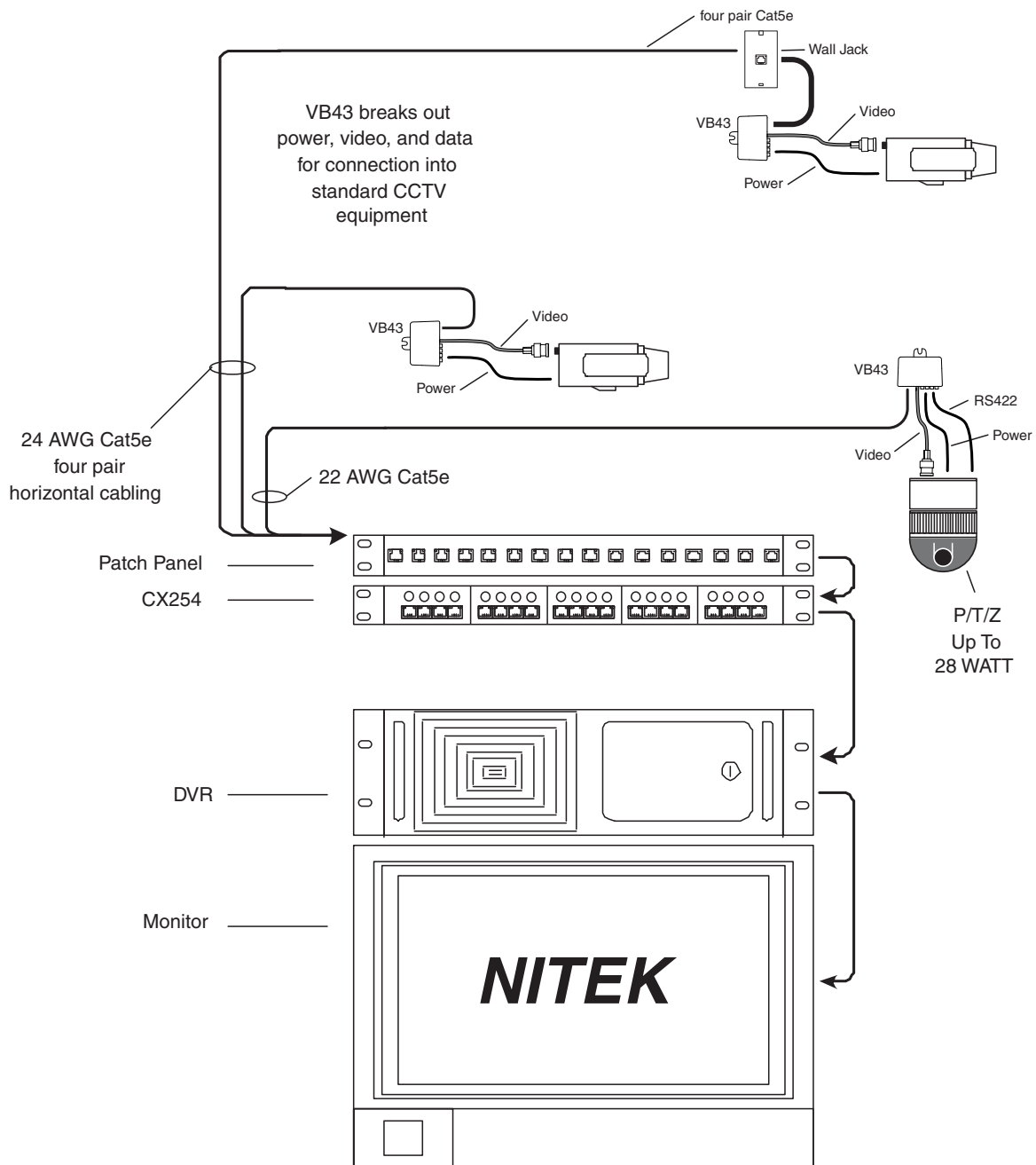

UTPLinks INTERMEDIATE POWER DISTRIBUTION

In a system, equipment is often spread out over a large facility and the communications backbone of that facility is used for the routing of the video and data signals. Power is inserted at the IDF (Telco closet) located closer to the camera end.

Starting at the camera end, there are several UTPLinks transmitter units available, only one is shown here. These units allow the video, power and data to be separated out and fed into standard CCTV cameras.

From the transmitter there is a standard 4 pair Category cable run back to a patch panel in the IDF, up to 100 meters away for TIA/EIA standards and 750 feet for standard analog fixed cameras. Distances for PTZ cameras are determined by the power requirements of the camera. From the patch panel each camera is sent to the CX254 unit. The CX254 unit provides a central point for the combining of the power, data and video signals. Each camera port is fused and lights on each of the front panel RJ45 jacks show the status of both power and data. Power for the system is provided by the CX254.

Video from and data to the cameras is routed through the RJ45 jacks on the rear of the CX254 unit. Signals are routed over a facilities backbone communication cable to the MDF (main Telcom center). From the MDF they can be re-routed to the security room.

In the security room these signals are taken back off of the backbone and put into NITEK video receiver units. Once they are decoded in the receiver units these video signals are fed out BNC jacks for connection into standard CCTV equipment. In our current example, a DVR is viewed on a monitor. It could have been a matrix, multiplexer or any other equipment needed for your application.

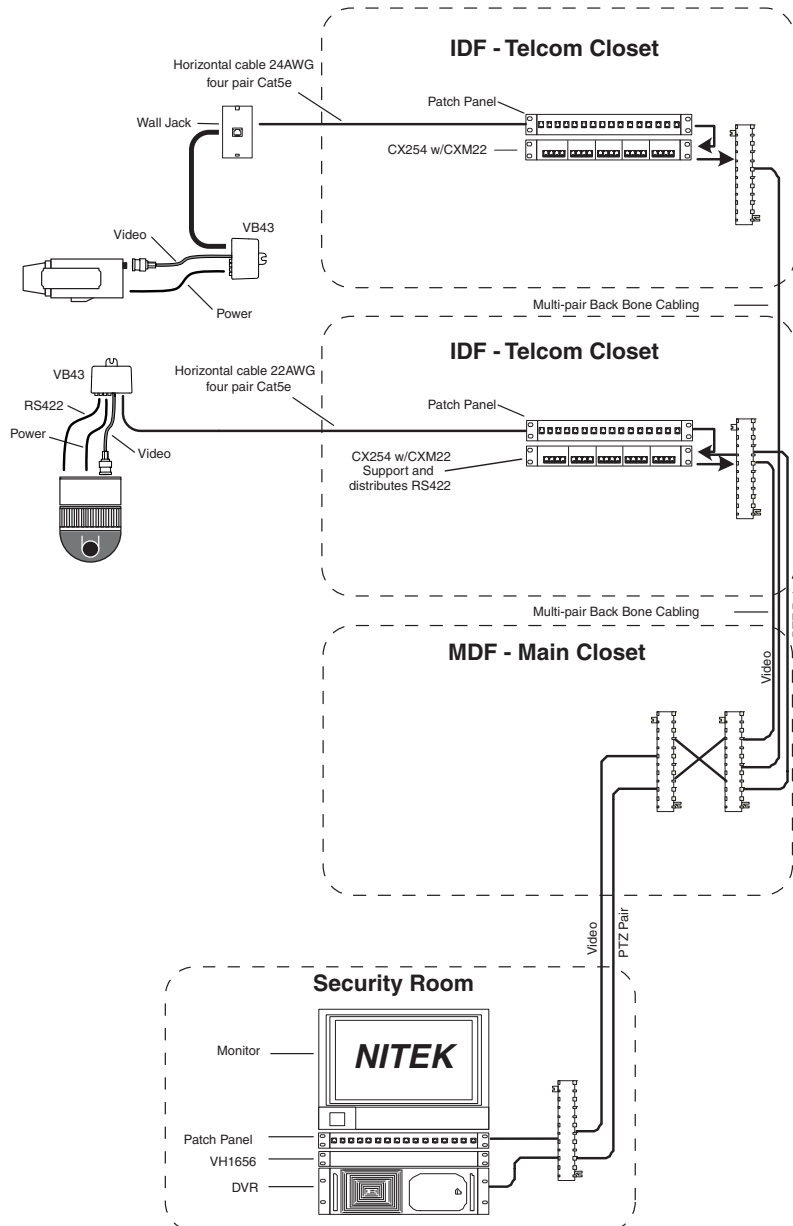

INSTALLATION

General Rules

- All horizontal cable runs from a CX254 unit to cameras must be 750 feet or less
- Fixed camera (10 watts or less) wire must be 24awg Cat 5 or better
- All PTZ cameras (10 to 21 watts) must be Cat 5e or better
- All cabling should be T568B wiring
- Always disconnect power to the system while working on the wiring

Step 1) Set the POWER Switch and connect the power cord

The CX254 unit can operate on 110VAC or 220VAC but a power selector switch on the rear panel must be properly set. **Please confirm that the rear panel power input selector switch is correct for your operating voltage. The unit is connected to main power using the IEC320 type C13 power plug on the rear of the unit. Make sure that you are using a power cord rated for 600 watts or greater.**

Step 2) Mounting the unit

The CX254 unit can be used as a desk top unit or rack mounted in a standard 19 inch rack. If you are rack mounting the unit refer to **APPENDIX A** for rack mounting instructions. Due to the weight and size, it is recommended that two persons work together in mounting the CX254 unit in a rack.

Step 3) Mount Cards in Card Cage

The CX254 unit has 5 card slots. When installing a card into the unit use the card guides for alignment. Use the #4 screw provided on the top to secure the card in place. Do not over tighten the locking screw. Unused card slots can be covered up with blank covers.

RJ45 jacks on the front of the card provide the connection for each camera run. To meet TIA/EIA standards your camera runs should be terminated in a patch panel. Using standard patch cables connect the camera ports to the patch panel. The camera runs should be wired for T568B standard.

Step 4) Connect Horizontal Runs

Before connecting each camera run to a card verify that it is properly wired, using the CAMERA PORT wiring chart below. The maximum output of any camera port is 21 watts. The maximum current output for all 4 camera ports on a card is 80 watts total.

Card Slots in front of CX254

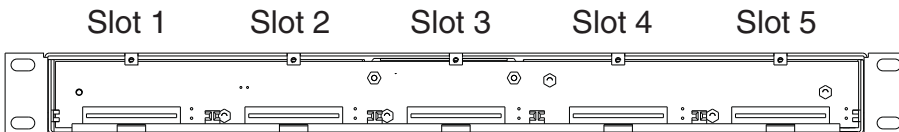

Camera Port Wire Chart

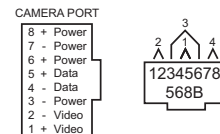

IF USING CHM22 CARDS

When using a CHM22 card the video for each camera is provided out the front of the card on BNC jacks. The decoded video can be fed into other equipment as needed. Control data for a PTZ can be connected to the 2 pin jack on the rear of the CX254.

IF USING CXM22 CARDS

When using a CXM22 card the video from each of the four camera runs is routed to a single RJ45 jack on the rear panel of the CX254 unit. Each card has its own RJ45 jack on the rear panel. Using a standard RJ45 cable you can then route the video signals on the copper backbone of the facility. Refer to the VIDEO PORT chart below for pin assignments. Control data for a PTZ can be connected using the 2 pin jack on the rear of the CX452.

Video Ports in back of CX254

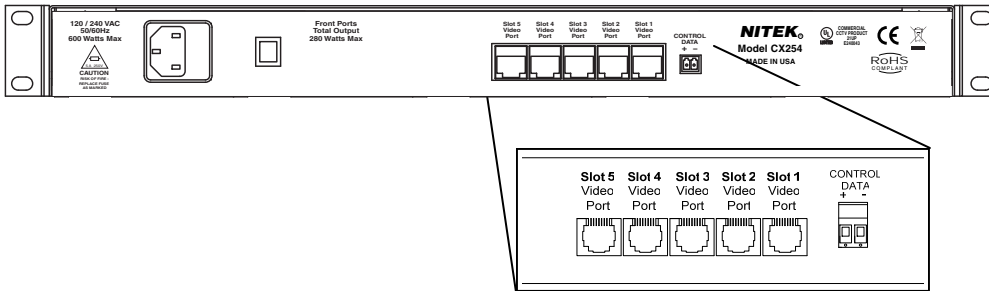

Video Port Wire Chart

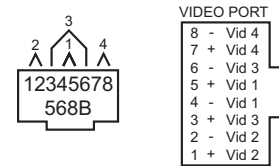

Card Slots in front of CX254

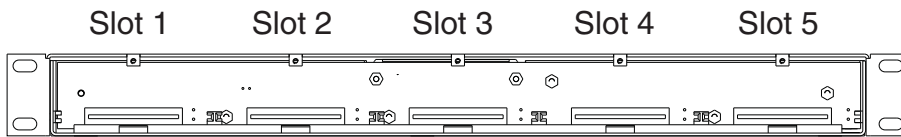

Camera Port Wire Chart

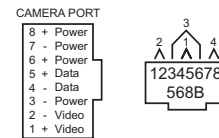

Step 5) At the Camera End

At the camera end there are several models of Balun Combiner units you can use. The particular model you choose will depend on your installation. For the connection of the Balun Combiner unit refer to the manual for your unit.

Technical Support

For additional help with problems please call NITEK Technical Assistance at (800) 528-4343. Hours are from 8am to 5pm Central Standard Time, Monday through Friday. We are always ready to help.

Appendix A

Installations for Rack Mounting CX254

This instruction page is only for rack mount units

Installation

The unit is supplied with two mounting ears. This allows the unit mount easily in any standard 19" rack cabinet. Using four screws in each mounting ear attach one ear to each side of the unit as is show in the illustrations below.

REVERSIBLE MOUNTING EARS

To reverse the ears, simply remove the 4 mounting screws per ear. Move ears to other side of cabinet. Reinstall mounting ears.

Location for mounting ears

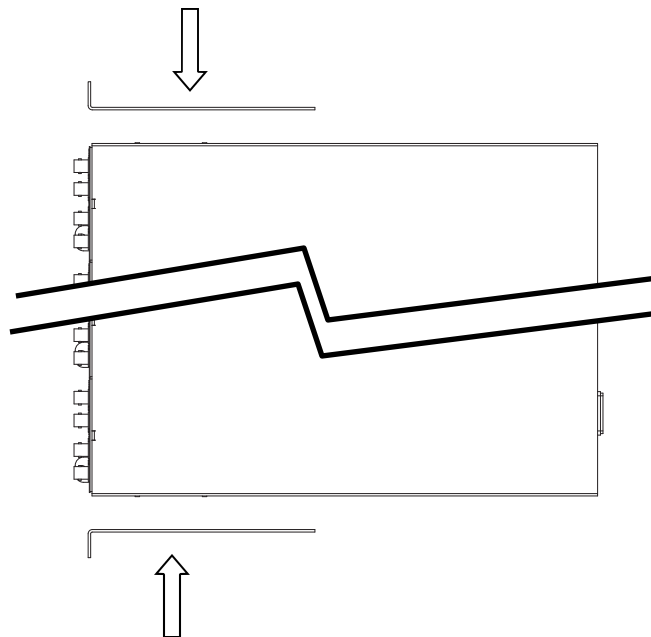

Location for screws to mount the ears.

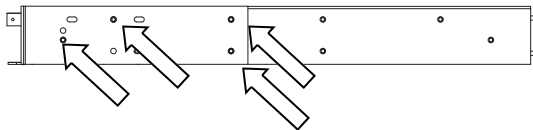

Finally, position the unit in the 19" rack and use 4 screws to properly secure the unit in position. Due to the weigh and size, it is recommended that two persons work together in mounting the CX254 unit in a rack.

